

**STRATO**

Módulos vitrina · Metallic black profile cabinets with glass doors · Armoire de toilette porte vitrée ou miroir · Moduli vetrina · Zusatzmodule vitrinenschrank · Дополнительные модули со стеклянными или зеркальными дверцами

**AUXILIARES - MIRROR CABINETS AND COLUMNS**

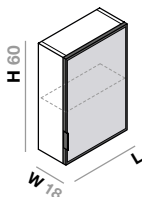

W min 13 cm

	Cod.	L	<b>AUGMENTATION DE PRIX</b>			
			LM	LB	S1	S3/S4
CR: Cristal incoloro / Untinted glass ES: Espejo / Untinted mirror	ST889	30	1149	1194	1273	1368
	ST890	40	1171	1218	1315	1417
	ST891	50	1213	1263	1376	1484
	ST892	60	1258	1309	1439	1553
CG: Cristal Gris / Grey tinted glass CB: Cristal Bronze / Bronze tinted glass EG: Espejo Gris / Grey tinted mirror EB: Espejo Bronze / Bronze tinted mirror	ST889	30	1132	1177	1257	1352
	ST890	40	1180	1227	1323	1425
	ST891	50	1227	1276	1388	1497
	ST892	60	1277	1328	1456	1571

ES Módulo auxiliar vitrina suspendido compuesto de una puerta y un estante interior.

IT Modulo ausiliare sospeso composto di una porta e un ripiano interno.

EN Wall mounted cabinet unit with one door and one internal shelf.

GE Zusätzliches Hängemodul bestehend aus einer Tür und einem innen liegenden Regalboden.

FR Armoire de toilette vitrée ou miroir à suspendre composée d'une porte et d'un étagère intérieure.

RU Подвесной дополнительный модуль с дверцей и внутренней полкой.

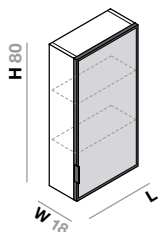

W min 13 cm

	Cod.	L	<b>AUGMENTATION DE PRIX</b>			
			LM	LB	S1	S3/S4
CR: Cristal incoloro / Untinted glass ES: Espejo / Untinted mirror	ST903	30	1304	1355	1386	1486
	ST904	40	1296	1351	1393	1500
	ST905	50	1353	1411	1460	1574
	ST906	60	1411	1473	1528	1648
CG: Cristal Gris / Grey tinted glass CB: Cristal Bronze / Bronze tinted glass EG: Espejo Gris / Grey tinted mirror EB: Espejo Bronze / Bronze tinted mirror	ST903	30	1242	1294	1330	1430
	ST904	40	1310	1365	1406	1513
	ST905	50	1344	1396	1445	1559
	ST906	60	1447	1509	1561	1681

ES Módulo auxiliar vitrina suspendido compuesto de una puerta y dos estantes interiores.

IT Modulo ausiliare vetrina sospeso composto da un'anta e due ripiani interni.

EN Wall mounted cabinet unit with one door and two internal shelves.

GE Zusatzmodul Vitrinenschrank Hängemodul, bestehend aus einer Tür und zwei Ablagen innen.

FR Armoire de toilette vitrée à suspendre composée d'une porte et deux étagères intérieures.

RU Дополнительный подвесной модуль с одной дверцей и двумя внутренними полками.

LM Laca Mate / Matt Lacquer / Laqué Mat / Laccato Opaco / Mattlack / Матовый лак  
 LB Laca Brillo / Glossy Lacquer / Laqué Brillant / Lacca Lucida / Glanzlack / Глянцевая медь

S1 Madera natural / Natural wood / Bois Naturel / Legno Naturale / Echtholz / Натуральное дерево  
 S3 Roble salvaje / Wild oak / Chêne sauvage / Rovere selvaggio / Natureiche / Дикая дуб  
 S4 Roble Raw / Raw oak / Chêne Raw / Rovere Raw / Roheiche / Raw дуб

## STRATO

Módulos vitrina · Metallic black profile cabinets with glass doors · Armoire de toilette porte vitrée ou miroir · Moduli vetrina · Zusatzmodule vitrinenschrank · Дополнительные модули со стеклянными или зеркальными дверцами

## AUXILIARES - MIRROR CABINETS AND COLUMNS

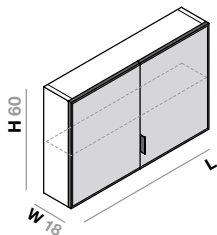

<b>ES</b>	Módulo auxiliar vitrina suspendido compuesto de dos puertas y un estante interior.	<b>IT</b>	Modulo ausiliare vetrina sospeso composto da due ante e un ripiano interno.
<b>EN</b>	Wall mounted cabinet unit with two doors and one internal shelf.	<b>GE</b>	Zusatzmodul Vitrinenschrank Hängemodul, bestehend aus zwei Türen und einer Ablage innen.
<b>FR</b>	Armoire de toilette vitrée ou miroir à suspendre composée de deux portes et une étagère.	<b>RU</b>	Дополнительный подвесной модуль с дверцей и двумя внутренними полками.

W min 13 cm

Cod.	L	AUGMENTATION DE PRIX			
		LM	LB	S1	S3/S4
ST893	60	1510	1562	1668	1783
ST894	80	1592	1648	1745	1866
ST895	90	1696	1755	1851	1977
ST896	100	1739	1799	1901	2032
ST897	120	1736	1801	1910	2048
ST893	60	1516	1568	1674	1788
ST894	80	1609	1665	1760	1881
ST895	90	1719	1777	1871	1997
ST896	100	1766	1827	1926	2057
ST897	120	1864	1929	2027	2165

CR: Cristal incoloro / Untinted glass  
ES: Espejo / Untinted mirror

CG: Cristal Gris / Grey tinted glass  
CB: Cristal Bronze / Bronze tinted glass  
EG: Espejo Gris / Grey tinted mirror  
EB: Espejo Bronze / Bronze tinted mirror

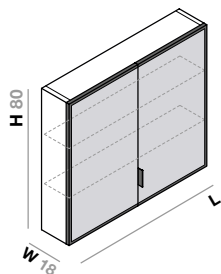

<b>ES</b>	Módulo auxiliar vitrina compuesto de dos puertas y dos estantes interiores.	<b>IT</b>	Modulo ausiliare vetrina composto da due ante e due ripiani interni.
<b>EN</b>	Wall mounted cabinet unit with two doors and two internal shelves.	<b>GE</b>	Zusatzmodul Vitrinenschrank, bestehend aus zwei Türen und zwei Ablagen innen.
<b>FR</b>	Armoire de toilette vitrée composée de deux portes et deux étagères intérieures.	<b>RU</b>	Дополнительный модуль с двумя дверцами и двумя внутренними полками.

W min 13 cm

Cod.	L	AUGMENTATION DE PRIX			
		LM	LB	S1	S3/S4
ST907	60	1676	1737	1768	1889
ST908	80	1854	1922	1915	2042
ST909	90	2028	2100	2077	2209
ST910	100	1969	2044	2026	2164
ST911	120	2114	2195	2152	2297
ST907	60	1688	1750	1780	1900
ST908	80	1882	1950	1941	2068
ST909	90	2094	2165	2136	2162
ST910	100	2072	2147	2120	2257
ST911	120	2165	2246	2198	2344

CR: Cristal incoloro / Untinted glass  
ES: Espejo / Untinted mirror

CG: Cristal Gris / Grey tinted glass  
CB: Cristal Bronze / Bronze tinted glass  
EG: Espejo Gris / Grey tinted mirror  
EB: Espejo Bronze / Bronze tinted mirror

LM Laca Mate / Matt Lacquer / Laqué Mat / Laccato Opaco / Mattlack / Матовый лак  
LB Laca Brillo / Glossy Lacquer / Laqué Brillant / Lacca Lucida / Glanzlack / Глянцевая медь

S1 Madera natural / Natural wood / Bois Naturel / Legno Naturale / Echtholz / Натуральное дерево  
S3 Roble salvaje / Wild oak / Chêne sauvage / Rovere selvaggio / Natureiche / Дикая дуб  
S4 Roble Raw / Raw oak / Chêne Raw / Rovere Raw / Roheiche / Raw дуб

**STRATO**

Módulos vitrina · Metallic black profile cabinets with glass doors · Armoire de toilette porte vitrée ou miroir · Moduli vetrina · Zusatzmodule vitrinenschrank · Дополнительные модули со стеклянными или зеркальными дверцами

**AUXILIARES - MIRROR CABINETS AND COLUMNS**

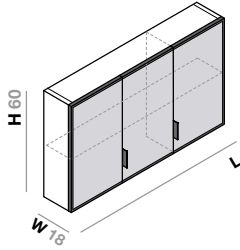

- ES Módulo auxiliar vitrina suspendido compuesto de tres puertas y un estante interior.
- EN Wall mounted cabinet unit with three doors and one internal shelf.
- FR Armoire de toilette vitrée ou miroir à suspendre composée de trois portes et une étagère.
- IT Modulo ausiliare vetrina sospeso composto da tre ante e un ripiano interno.
- GE Zusatzmodul Vitrinenschrank Hängemodul, bestehend aus drei Türen und einer Ablage innen.
- RU Дополнительный подвесной модуль с тремя дверцами и внутренней полкой.

Observación: Los módulos ≤ L180 son indivisibles y se sirven en una única pieza / Units of ≤ L180 in length are one single unit and shipped as one / Les meubles ≤ L180 sont indivisibles et sont servis en une seule pièce / I moduli di ≤ L180 sono indivisibili e si forniscono in un solo pezzo / Die Module ≤ L180 werden als ganzes Stück geliefert und sind nicht einzeln erhältlich / Модули ≤ L180 выполнены в виде моноблока и поставляются в единичном экземпляре

W min 13 cm

Cod.	L	AUGMENTATION DE PRIX			
		LM	LB	S1	S3/S4
ST898	90	2063	2132	2083	2208
ST899	120	2122	2192	2220	2358
ST900	140	2379	2459	2404	2550
ST901	150	2431	2513	2462	2613
ST902	160	2454	2539	2496	2651
ST898	90	2072	2141	2091	2217
ST899	120	2148	2217	2243	2381
ST900	140	2410	2490	2432	2578
ST901	150	2472	2554	2500	2650
ST902	160	2490	2575	2528	2684

CR: Cristal incoloro / Untinted glass  
ES: Espejo / Untinted mirror

CG: Cristal Gris / Grey tinted glass  
CB: Cristal Bronze / Bronze tinted glass  
EG: Espejo Gris / Grey tinted mirror  
EB: Espejo Bronze / Bronze tinted mirror

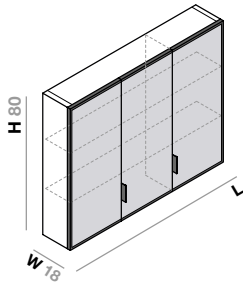

- ES Módulo auxiliar vitrina suspendido compuesto de tres puertas y dos estantes interiores.
- EN Wall mounted cabinet unit with three doors and two internal shelves.
- FR Armoire de toilette vitrée ou miroir à suspendre composée de trois portes et deux étagères.
- IT Modulo ausiliare vetrina sospeso composto da tre ante e due ripiani interni.
- GE Zusatzmodul Vitrinenschrank Hängemodul, bestehend aus drei Türen und zwei Ablagen innen.
- RU Дополнительный подвесной модуль с тремя дверцами и двумя внутренними полками.

W min 13 cm

Cod.	L	AUGMENTATION DE PRIX			
		LM	LB	S1	S3/S4
ST912	90	2398	2482	2293	2425
ST913	120	2484	2578	2368	2514
ST914	140	2736	2837	2592	2745
ST915	150	2771	2875	2627	2785
ST916	160	2876	2983	2726	2889
ST912	90	2441	2526	2333	2465
ST913	120	2526	2620	2407	2552
ST914	140	2802	2903	2652	2805
ST915	150	2837	2941	2687	2845
ST916	160	2964	3071	2806	2969

CR: Cristal incoloro / Untinted glass  
ES: Espejo / Untinted mirror

CG: Cristal Gris / Grey tinted glass  
CB: Cristal Bronze / Bronze tinted glass  
EG: Espejo Gris / Grey tinted mirror  
EB: Espejo Bronze / Bronze tinted mirror

LM Laca Mate / Matt Lacquer / Laqué Mat / Laccato Opaco / Mattlack / Матовый лак  
LB Laca Brillo / Glossy Lacquer / Laqué Brillant / Lacca Lucida / Glanzlack / Глянцевая медь

S1 Madera natural / Natural wood / Bois Naturel / Legno Naturale / Echtholz / Натуральное дерево  
S3 Roble salvaje / Wild oak / Chêne sauvage / Rovere selvaggio / Natureiche / Дикий дуб  
S4 Roble Raw / Raw oak / Chêne Raw / Rovere Raw / Roheiche / Raw дуб

## STRATO

Módulos vitrina · Metallic black profile cabinets with glass doors · Armoire de toilette porte vitrée ou miroir · Moduli vetrina · Zusatzmodule vitrinenschrank · Дополнительные модули со стеклянными или зеркальными дверцами

## AUXILIARES - MIRROR CABINETS AND COLUMNS

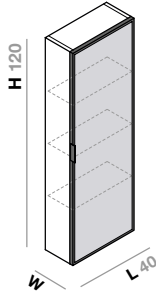

ES	Espejo camerino vitrina suspendido compuesto de una puerta y tres estantes interiores.	IT	Armadietto specchiera vetrina composto da un'anta e tre ripiani interni.
EN	Wall mounted cabinet unit with one door and three internal shelves.	GE	Zusatzmodul Vitrinenschrank Spiegel, bestehend aus einer Tür und drei Ablagen innen.
FR	Armoire de toilette vitrée ou miroir à suspendre composée d'une porte et trois étagères.	RU	Зеркальный шкаф с одной дверцей и тремя внутренними полками.

### AUGMENTATION DE PRIX

W min 13 cm

	Cod.	W	LM	LB	S1	S3/S4
CR: Cristal incoloro / Untinted glass ES: Espejo / Untinted mirror	ST917	18	1535	1599	1638	1761
	ST918	30	1644	1719	1763	1905
CG: Cristal Gris / Grey tinted glass CB: Cristal Bronze / Bronze tinted glass EG: Espejo Gris / Grey tinted mirror EB: Espejo Bronze / Bronze tinted mirror	ST917	18	1516	1579	1620	1744
	ST918	30	1625	1699	1745	1887

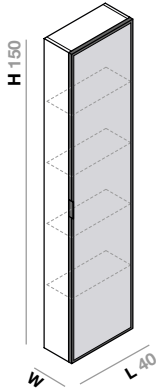

ES	Módulo auxiliar vitrina suspendido compuesto de una puerta y cuatro estantes interiores.	IT	Modulo ausiliare vetrina composto da un'anta e quattro ripiani interni.
EN	Wall mounted cabinet unit with one door and four internal shelves.	GE	Zusatzmodul Vitrinenschrank, bestehend aus einer Tür und vier Ablagen innen.
FR	Armoire de toilette vitrée ou miroir à suspendre composée d'une porte et quatre étagères.	RU	Дополнительный модуль с одной дверцей и четырьмя внутренними полками.

### AUGMENTATION DE PRIX

W min 13 cm

	Cod.	W	LM	LB	S1	S3/S4
CR: Cristal incoloro / Untinted glass ES: Espejo / Untinted mirror	ST919	25	1667	1741	1875	2030
	ST920	40	1805	1893	1877	2033
CG: Cristal Gris / Grey tinted glass CB: Cristal Bronze / Bronze tinted glass EG: Espejo Gris / Grey tinted mirror EB: Espejo Bronze / Bronze tinted mirror	ST919	25	1764	1838	1963	2118
	ST920	40	1902	1989	2119	2274
CE: Cristal Estriado / Fluted Glass RB: Reflectivo Bronze / Bronze Reflective	ST919	25	1940	2022	2159	2329
	ST920	40	2092	2188	2331	2501

LM Laca Mate / Matt Lacquer / Laqué Mat / Laccato Opaco / Mattlack / Матовый лак  
LB Laca Brillo / Glossy Lacquer / Laqué Brillant / Lacca Lucida / Glanzlack / Глянцевая медь

S1 Madera natural / Natural wood / Bois Naturel / Legno Naturale / Echtholz / Натуральное дерево  
S3 Roble salvaje / Wild oak / Chêne sauvage / Rovere selvaggio / Natureiche / Дикая дуб  
S4 Roble Raw / Raw oak / Chêne Raw / Rovere Raw / Roheiche / Raw дуб

## STRATO

Módulos vitrina · Metallic black profile cabinets with glass doors · Armoire de toilette porte vitrée ou miroir · Moduli vetrina · Zusatzmodule vitrinenschrank · Дополнительные модули со стеклянными или зеркальными дверцами

## AUXILIARES - MIRROR CABINETS AND COLUMNS

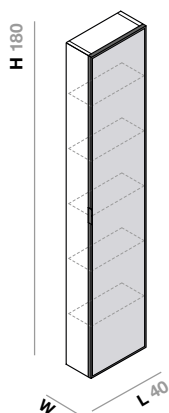

W min 13 cm

ES	Módulo auxiliar vitrina suspendido compuesto de una puerta y cinco estantes interiores.	IT	Modulo ausiliare vetrina composto da un'anta e cinque ripiani interni.
EN	Wall mounted cabinet unit with one door and five internal shelves.	GE	Zusatzmodul Vitrinenschrank, bestehend aus einer Tür und fünf Ablagen innen.
FR	Armoire de toilette vitrée ou miroir à suspendre composée d'une porte et cinq étagères.	RU	Дополнительный модуль с одной дверцей и пятью внутренними полками.

### AUGMENTATION DE PRIX

	Cod.	W	LM	LB	S1	S3/S4
CR: Cristal incoloro / Untinted glass	ST921	25	1790	1871	2126	2311
ES: Espejo / Untinted mirror	ST922	40	1956	2053	2251	2455
CG: Cristal Gris / Grey tinted glass	ST921	25	1836	1917	2168	2353
CB: Cristal Bronze / Bronze tinted glass	ST921	25	1836	1917	2168	2353
EG: Espejo Gris / Grey tinted mirror	ST922	40	2003	2100	2294	2497
EB: Espejo Bronze / Bronze tinted mirror	ST922	40	2003	2100	2294	2497
CE: Cristal Estriado / Fluted Glass	ST921	25	2020	2109	2385	2589
RB: Reflectivo Bronze / Bronze Reflective	ST922	40	2203	2310	2523	2747

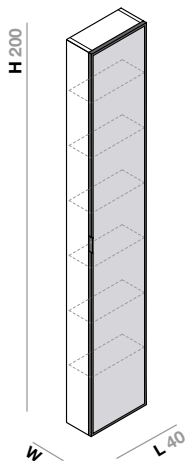

W min 13 cm

ES	Módulo auxiliar vitrina al suelo compuesto de una puerta y seis estantes interiores.	IT	Modulo ausiliare vetrina composto da un'anta e sei ripiani interni.
EN	Wall mounted cabinet unit with one door and six internal shelves.	GE	Zusatzmodul Vitrinenschrank, bestehend aus einer Tür und sechs Ablagen innen.
FR	Armoire de toilette vitrée ou miroir au sol composée d'une porte et six étagères.	RU	Дополнительный модуль с одной дверцей и шестью внутренними полками.

### AUGMENTATION DE PRIX

	Cod.	W	LM	LB	S1	S3/S4
CR: Cristal incoloro / Untinted glass	ST923	25	1972	2062	2427	2645
ES: Espejo / Untinted mirror	ST924	40	2169	2279	2578	2818
CG: Cristal Gris / Grey tinted glass	ST923	25	2024	2114	2474	2692
CB: Cristal Bronze / Bronze tinted glass	ST923	25	2024	2114	2474	2692
EG: Espejo Gris / Grey tinted mirror	ST924	40	2221	2330	2625	2865
EB: Espejo Bronze / Bronze tinted mirror	ST924	40	2221	2330	2625	2865
CE: Cristal Estriado / Fluted Glass	ST923	25	2226	2325	2721	2961
RB: Reflectivo Bronze / Bronze Reflective	ST924	40	2443	2563	2888	3152

LM Laca Mate / Matt Lacquer / Laqué Mat / Laccato Opaco / Mattlack / Матовый лак  
LB Laca Brillo / Glossy Lacquer / Laqué Brillant / Lacca Lucida / Glanzlack / Глянцевая медь

S1 Madera natural / Natural wood / Bois Naturel / Legno Naturale / Echtholz / Натуральное дерево  
S3 Roble salvaje / Wild oak / Chêne sauvage / Rovere selvaggio / Natureiche / Дикая дуб  
S4 Roble Raw / Raw oak / Chêne Raw / Rovere Raw / Roheiche / Raw дуб

## STRATO

Módulos vitrina · Metallic black profile cabinets with glass doors · Armoire de toilette porte vitrée ou miroir · Moduli vetrina · Zusatzmodule vitrinenschrank · Дополнительные модули со стеклянными или зеркальными дверцами

## AUXILIARES - MIRROR CABINETS AND COLUMNS

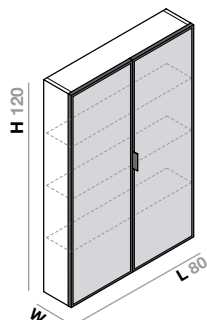

ES	Módulo auxiliar vitrina compuesto de dos puertas y tres estantes interiores.	IT	Modulo ausiliare vetrina composto da due ante e tre ripiani interni.
EN	Wall mounted cabinet unit with two doors and three internal shelves.	GE	Zusatzmodul Vitrinenschrank, bestehend aus einer Tür und drei Ablagen innen.
FR	Armoire de toilette vitrée ou miroir à suspendre composée de deux portes et trois étagères.	RU	Дополнительный модуль с двумя дверцами и тремя внутренними полками.

W min 13 cm

### AUGMENTATION DE PRIX

Cod.	W	LM	LB	S1	S3/S4
CR: Cristal incoloro / Untinted glass ES: Espejo / Untinted mirror	ST1140 18 ST1141 30	2783 2981	2899 3116	2970 3197	3194 3454
CG: Cristal Gris / Grey tinted glass CB: Cristal Bronze / Bronze tinted glass EG: Espejo Gris / Grey tinted mirror EB: Espejo Bronze / Bronze tinted mirror	ST1140 18 ST1141 30	2748 2946	2864 3081	2938 3165	3162 3422

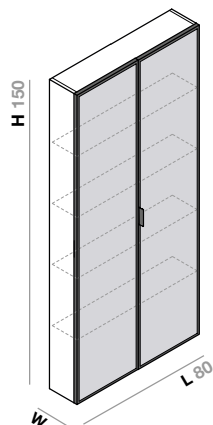

ES	Módulo auxiliar vitrina compuesto de dos puertas y cuatro estantes interiores.	IT	Modulo ausiliare vetrina composto da due ante e quattro ripiani interni.
EN	Wall mounted cabinet unit with two doors and four internal shelves.	GE	Zusatzmodul Vitrinenschrank, bestehend aus einer Tür und vier Ablagen innen.
FR	Armoire de toilette vitrée ou miroir à suspendre composée de deux portes et quatre étagères.	RU	Дополнительный модуль с двумя дверцами и четырьмя внутренними полками.

W min 13 cm

### AUGMENTATION DE PRIX

Cod.	W	LM	LB	S1	S3/S4
CR: Cristal incoloro / Untinted glass ES: Espejo / Untinted mirror	ST1142 25 ST1143 40	3023 3273	3158 3432	3400 3403	3681 3686
CG: Cristal Gris / Grey tinted glass CB: Cristal Bronze / Bronze tinted glass EG: Espejo Gris / Grey tinted mirror EB: Espejo Bronze / Bronze tinted mirror	ST1142 25 ST1143 40	3198 3448	3332 3607	3559 3842	3840 4123
CE: Cristal Estriado / Fluted Glass RB: Reflectivo Bronze / Bronze Reflective	ST1142 25 ST1143 40	3518 3793	3666 3967	3915 4226	4224 4535

LM Laca Mate / Matt Lacquer / Laqué Mat / Laccato Opaco / Mattlack / Матовый лак  
LB Laca Brillo / Glossy Lacquer / Laqué Brillant / Lacca Lucida / Glanzlack / Глянцевая медь

S1 Madera natural / Natural wood / Bois Naturel / Legno Naturale / Echtholz / Натуральное дерево  
S3 Roble salvaje / Wild oak / Chêne sauvage / Rovere selvaggio / Natureiche / Дикая дуб  
S4 Roble Raw / Raw oak / Chêne Raw / Rovere Raw / Roheiche / Raw дуб

## STRATO

Módulos vitrina · Metallic black profile cabinets with glass doors · Armoire de toilette porte vitrée ou miroir · Moduli vetrina · Zusatzmodule vitrinenschrank · Дополнительные модули со стеклянными или зеркальными дверцами

## AUXILIARES - MIRROR CABINETS AND COLUMNS

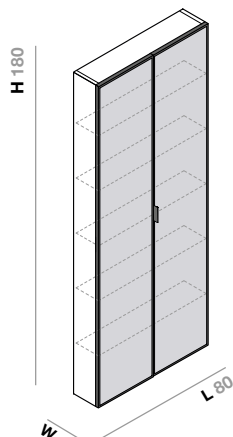

W min 13 cm

ES	Módulo auxiliar vitrina compuesto de dos puertas y cinco estantes interiores.	IT	Modulo ausiliare vetrina composto da due ante e cinque ripiani interni.
EN	Wall mounted cabinet unit with two doors and five internal shelves.	GE	Zusatzmodul Vitrinenschrank, bestehend aus einer Tür und fünf Ablagen innen.
FR	Armoire de toilette vitrée ou miroir à suspendre composée de deux portes et cinq étagères.	RU	Дополнительный модуль с двумя дверцами и пятью внутренними полками.

### AUGMENTATION DE PRIX

	Cod.	W	LM	LB	S1	S3/S4
CR: Cristal incoloro / Untinted glass	ST1144	25	3246	3392	3855	4191
ES: Espejo / Untinted mirror	ST1145	40	3547	3723	4082	4451
CG: Cristal Gris / Grey tinted glass	ST1144	25	3330	3477	3932	4267
CB: Cristal Bronze / Bronze tinted glass	ST1144	25	3330	3477	3932	4267
EG: Espejo Gris / Grey tinted mirror	ST1145	40	3631	3808	4159	4528
EB: Espejo Bronze / Bronze tinted mirror	ST1145	40	3631	3808	4159	4528
CE: Cristal Estriado / Fluted Glass	ST1144	25	3663	3824	4325	4694
RB: Reflectivo Bronze / Bronze Reflective	ST1145	40	3995	4188	4575	4981

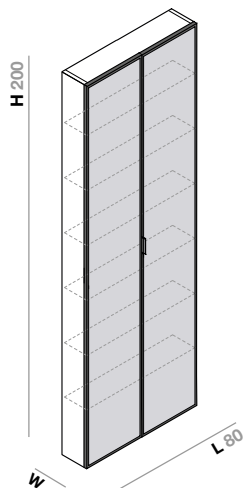

W min 13 cm

ES	Módulo auxiliar vitrina compuesto de dos puertas y seis estantes interiores	IT	Modulo ausiliare vetrina composto da due ante e sei ripiani interni.
EN	Wall mounted cabinet unit with two doors and six internal shelves.	GE	Zusatzmodul Vitrinenschrank, bestehend aus einer Tür und sechs Ablagen innen.
FR	Armoire de toilette vitrée ou miroir au sol composée de deux portes et six étagères.	RU	Дополнительный модуль с двумя дверцами и шестью внутренними полками.

### AUGMENTATION DE PRIX

	Cod.	W	LM	LB	S1	S3/S4
CR: Cristal incoloro / Untinted glass	ST1146	25	3576	3739	4401	4796
ES: Espejo / Untinted mirror	ST1147	40	3934	4132	4675	5110
CG: Cristal Gris / Grey tinted glass	ST1146	25	3670	3833	4486	4881
CB: Cristal Bronze / Bronze tinted glass	ST1146	25	3670	3833	4486	4881
EG: Espejo Gris / Grey tinted mirror	ST1147	40	4027	4225	4760	5195
EB: Espejo Bronze / Bronze tinted mirror	ST1147	40	4027	4225	4760	5195
CE: Cristal Estriado / Fluted Glass	ST1146	25	4037	4216	4935	5370
RB: Reflectivo Bronze / Bronze Reflective	ST1147	40	4430	4648	5236	5715

LM Laca Mate / Matt Lacquer / Laqué Mat / Laccato Opaco / Mattlack / Матовый лак  
LB Laca Brillo / Glossy Lacquer / Laqué Brillant / Lacca Lucida / Glanzlack / Глянцевая медь

S1 Madera natural / Natural wood / Bois Naturel / Legno Naturale / Echtholz / Натуральное дерево  
S3 Roble salvaje / Wild oak / Chêne sauvage / Rovere selvaggio / Natureiche / Дикая дуб  
S4 Roble Raw / Raw oak / Chêne Raw / Rovere Raw / Roheiche / Raw дуб

## STRATO

Módulos vitrina · Metallic black profile cabinets with glass doors · Armoire de toilette porte vitrée ou miroir · Moduli vetrina · Zusatzmodule vitrinenschrank · Дополнительные модули со стеклянными или зеркальными дверцами

## AUXILIARES - MIRROR CABINETS AND COLUMNS

Complementos para módulos auxiliares vitrina / Cabinet unit accessories / Compléments Pour Meubles D'appoints Vitrés / Complementi per moduli ausiliari vetrina / Zubehör für Zusatzmodule Vitrinenschrank / аксессуары для дополнительных модулей



ES	Base de enchufe interior doble. Instalado en el mueble.	IT	Presa interna doppia. Installato nel mobile.
EN	Interior socket with two outlets. Installed into the unit.	GE	Innen liegende doppelsteckdose. Installiert im Möbel.
FR	Prise électrique double. Installée à l'intérieur du meuble.	RU	Двойная внутренняя розетка. Встроена в модуль.

Cod.

EF010

**AUGMENTATION DE PRIX**

191

**IP44**

**CE UK CA IP41**

Cod.

EF010 UK 115V / 230V dual voltage shaver socket with two outlets. Installed into the unit.

381



ES	2 líneas de iluminación LED interior lateral para módulos de diferente alto (H). Encendido mediante sensor al abrir la puerta en puertas espejo o encendido mediante toma directa a corriente para puertas en cristal.	IT	2 strisce di illuminazione LED interna laterale per moduli di diversa altezza (H). Accensione mediante sensore di apertura dell'anta in ante con specchio o accensione mediante presa di corrente diretta per ante di vetro.
EN	Two interior side lighting LED stripes for cabinets of different heights (H). Sensor-controlled light switching when opening/closing the door needs to be added.	GE	Zwei seitliche Lichtlinien LED innen, für Module in verschiedener Höhe (H). Automatisches Einschalten durch Sensor beim Öffnen der Tür, Tür mit Spiegel. Einschaltfunktion für Tür aus Kristall: Direktanschluss.
FR	Deux bandes latérales intérieures d'éclairage LED pour meubles de différentes hauteur (H). Mise en marche à l'aide d'un capteur lors de l'ouverture de la porte miroir ou directement par prise de courant pour les portes vitrées.	RU	2 линии внутренней боковой LED-подсветки для модулей разной высоты (H). Включение от датчика в момент открытия зеркальных дверец или с помощью электрического выключателя для модулей со стеклянными дверцами.

Cod.	H	
IL061	40	282
IL062	60	298
IL063	80	315
IL065	120	350
IL067	150	434
IL068	180	459
IL069	200	477

Solo para puertas espejo / Only for mirror doors is required

CF002 Sensor / Capteur / Sensore / Датчика 139



## STRATO

Módulos vitrina empotrados · Recessed Metallic black profile cabinets with glass doors · Armoires de toilette vitrées ou miroirs encastrées · Moduli con vetrina ad incasso · Kleinmöbel Module Einbauvitrine · Модули дополнительные встраиваемые со стеклянными или зеркальными дверцами

## AUXILIARES - MIRROR CABINETS AND COLUMNS

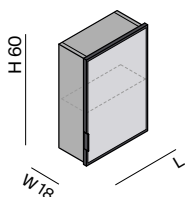

<b>ES</b>	Módulo auxiliar vitrina suspendido compuesto de una puerta y un estante interior.	<b>IT</b>	Modulo ausiliare sospeso composto di una porta e un ripiano interno.
<b>EN</b>	Wall mounted cabinet unit with one door and one internal shelf.	<b>GE</b>	Zusätzliches Hängemodul bestehend aus einer Tür und einem innen liegenden Regalboden.
<b>FR</b>	Armoire de toilette vitrée ou miroir encastrée à suspendre. Une porte et une étagère.	<b>RU</b>	Подвесной дополнительный модуль с дверцей и внутренней полкой.

 W min 13 cm

	Cod.	L	AUGMENTATION DE PRIX		
			A	S1	S3/S4
CR: Cristal Incoloro / Untinted glass ES: Espejo / Untinted mirror	ST1102	20	893	1165	1340
	ST1103	30	922	1185	1363
	ST1104	40	966	1253	1441
	ST1105	50	1010	1321	1519
	ST1106	60	1053	1389	1598
	CG: Cristal Gris / Grey tinted glass CB: Cristal Bronze / Bronze tinted glass EG: Espejo Gris / Grey tinted mirror EB: Espejo Bronze / Bronze tinted mirror	ST1102	20	901	1172
ST1103		30	935	1198	1377
ST1104		40	982	1269	1459
ST1105		50	1029	1340	1541
ST1106		60	1078	1412	1624

A Antracita / Anthracite / Anthracite / Antracite / Anthrazit / Антрацит

S1 Madera natural / Natural wood / Bois Naturel / Legno Naturale / Echtholz / Натуральное дерево

S3 Roble salvaje / Wild oak / Chêne sauvage / Rovere selvaggio / Natureiche / Дикий дуб

S4 Roble Raw / Raw oak / Chêne Raw / Rovere Raw / Roheiche / Raw дуб

## STRATO

Módulos vitrina empotrados · Recessed Metallic black profile cabinets with glass doors · Armoires de toilette vitrées ou miroirs encastrées · Moduli con vetrina ad incasso · Kleinmöbel Module Einbauvitrine · Модули дополнительные встраиваемые со стеклянными или зеркальными дверцами

## AUXILIARES - MIRROR CABINETS AND COLUMNS

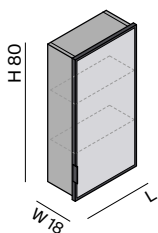

W min 13 cm

ES	Módulo auxiliar vitrina suspendido compuesto de una puerta y dos estantes interiores.	IT	Modulo ausiliare vetrina sospeso composto da un'anta e due ripiani interni.
EN	Wall mounted cabinet unit with one door and two internal shelves.	GE	Zusatzmodul Vitrinenschrank Hängemodul, bestehend aus einer Tür und zwei Ablagen innen.
FR	Armoire de toilette vitrée ou miroir encastrée à suspendre. Une porte et deux étagères.	RU	Дополнительный подвесной модуль с одной дверцей и двумя внутренними полками.

### AUGMENTATION DE PRIX

	Cod.	L	A	S1	S3/S4
CR: Cristal Incoloro / Untinted glass ES: Espejo / Untinted mirror	ST1117	20	1006	1252	1440
	ST1118	30	1032	1276	1468
	ST1119	40	1115	1375	1582
	ST1120	50	1165	1443	1660
	ST1121	60	1222	1517	1745
CG: Cristal Gris / Grey tinted glass CB: Cristal Bronze / Bronze tinted glass EG: Espejo Gris / Grey tinted mirror EB: Espejo Bronze / Bronze tinted mirror	ST1117	20	1016	1261	1450
	ST1118	30	1044	1287	1480
	ST1119	40	1130	1389	1598
	ST1120	50	1191	1469	1690
	ST1121	60	1253	1548	1780

A Antracita / Anthracite / Anthracite / Antracite / Anthrazit / Антрацит

S1 Madera natural / Natural wood / Bois Naturel / Legno Naturale / Echtholz / Натуральное дерево

S3 Roble salvaje / Wild oak / Chêne sauvage / Rovere selvaggio / Natureiche / Дикая дуб

S4 Roble Raw / Raw oak / Chêne Raw / Rovere Raw / Roheiche / Raw дуб

## STRATO

Módulos vitrina empotrados - Recessed Metallic black profile cabinets with glass doors - Armoires de toilette vitrées ou miroirs encastrées - Moduli con vetrina ad incasso - Kleinmöbel Module Einbauvitrine - Модули дополнительные встраиваемые со стеклянными или зеркальными дверцами

## AUXILIARES - MIRROR CABINETS AND COLUMNS

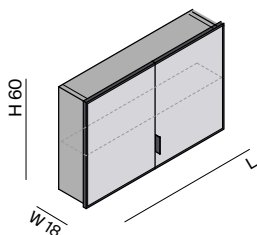

W min 13 cm

ES	Módulo auxiliar vitrina suspendido compuesto de dos puertas y un estante interior.	IT	Modulo ausiliare vetrina sospeso composto da due ante e un ripiano interno.
EN	Wall mounted cabinet unit with two doors and one internal shelf.	GE	Zusatzmodul Vitrinenschrank Hängemodul, bestehend aus zwei Türen und einer Ablage innen.
FR	Armoire de toilette vitrée ou miroir encastrée à suspendre. Deux portes et une étagère.	RU	Дополнительный подвесной модуль с дверцей и двумя внутренними полками.

### AUGMENTATION DE PRIX

Cod.	L	A	S1	S3/S4
ST1107	60	984	1323	1521
ST1108	80	1394	1724	1983
ST1109	90	1436	1780	2047
ST1110	100	1480	1835	2111
ST1111	120	1567	1939	2229
ST1107	60	997	1334	1534
ST1108	80	1426	1753	2016
ST1109	90	1472	1814	2086
ST1110	100	1519	1874	2155
ST1111	120	1614	1983	2281

CR: Cristal incoloro / Untinted glass  
ES: Espejo / Untinted mirror

CG: Cristal Gris / Grey tinted glass  
CB: Cristal Bronze / Bronze tinted glass  
EG: Espejo Gris / Grey tinted mirror  
EB: Espejo Bronze / Bronze tinted mirror

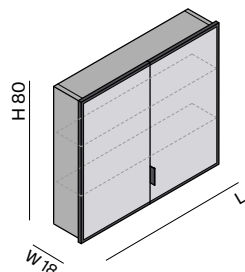

W min 13 cm

ES	Módulo auxiliar vitrina compuesto de dos puertas y dos estantes interiores.	IT	Modulo ausiliare vetrina composto da due ante e due ripiani interni.
EN	Wall mounted cabinet unit with two doors and two internal shelves.	GE	Zusatzmodul Vitrinenschrank, bestehend aus zwei Türen und zwei Ablagen innen.
FR	Armoire de toilette vitrée ou miroir encastrée à suspendre. Deux portes et deux étagères.	RU	Дополнительный модуль с двумя дверцами и двумя внутренними полками.

### AUGMENTATION DE PRIX

Cod.	L	A	S1	S3/S4
ST1122	60	1455	1741	2002
ST1123	80	1614	1889	2173
ST1124	90	1664	1948	2240
ST1125	100	1715	2005	2306
ST1126	120	1827	2118	2435
ST1122	60	1476	1761	2025
ST1123	80	1645	1919	2206
ST1124	90	1707	1986	2284
ST1125	100	1768	2056	2364
ST1126	120	1890	2178	2505

CR: Cristal incoloro / Untinted glass  
ES: Espejo / Untinted mirror

CG: Cristal Gris / Grey tinted glass  
CB: Cristal Bronze / Bronze tinted glass  
EG: Espejo Gris / Grey tinted mirror  
EB: Espejo Bronze / Bronze tinted mirror

A Antracita / Anthracite / Anthracite / Antracite / Anthrazit / Антрацит

S1 Madera natural / Natural wood / Bois Naturel / Legno Naturale / Echtholz / Натуральное дерево

S3 Roble salvaje / Wild oak / Chêne sauvage / Rovere selvaggio / Natureiche / Дикая дуб

S4 Roble Raw / Raw oak / Chêne Raw / Rovere Raw / Roheiche / Raw дуб

**STRATO**

Módulos vitrina empotrados - Recessed Metallic black profile cabinets with glass doors - Armoires de toilette vitrées ou miroirs encastrées - Moduli con vetrina ad incasso - Kleinmöbel Module Einbauvitrine - Модули дополнительные встраиваемые со стеклянными или зеркальными дверцами

**AUXILIARES - MIRROR CABINETS AND COLUMNS**

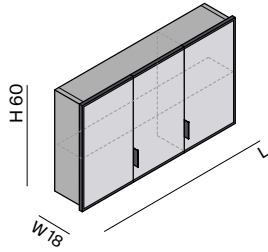

- ES Módulo auxiliar vitrina suspendido compuesto de tres puertas y un estante interior.
- IT Modulo ausiliare vetrina sospeso composto da tre ante e un ripiano interno.
- EN Wall mounted cabinet unit with three doors and one internal shelf.
- GE Zusatzmodul Vitrinenschrank Hängemodul, bestehend aus drei Türen und einer Ablage innen.
- FR Armoire de toilette vitrée ou miroir encastrée à suspendre. Trois portes et une étagère.
- RU Дополнительный подвесной модуль с тремя дверцами и внутренней полкой.

Observación: Los módulos ≤ L180 son indivisibles y se sirven en una única pieza / Units of ≤ L180 in length are one single unit and shipped as one / Les meubles ≤ L180 sont indivisibles et sont servis en une seule pièce / I moduli di ≤ L180 sono indivisibili e si forniscono in un solo pezzo / Die Module ≤ L180 werden als ganzes Stück geliefert und sind nicht einzeln erhältlich / Модули ≤ L180 выполнены в виде моноблока и потому н

**AUGMENTATION DE PRIX**

W min 13 cm

Cod.	L	A	S1	S3/S4
ST1112	90	1762	2011	2313
ST1113	120	2024	2297	2641
ST1114	140	2029	2320	2668
ST1115	150	2013	2363	2718
ST1116	160	2256	2567	2952
ST1112	90	1796	2044	2350
ST1113	120	2096	2365	2719
ST1114	140	2094	2382	2739
ST1115	150	2073	2420	2783
ST1116	160	2327	2635	3030

CR: Cristal incoloro / Untinted glass  
ES: Espejo / Untinted mirror

CG: Cristal Gris / Grey tinted glass  
CB: Cristal Bronze / Bronze tinted glass  
EG: Espejo Gris / Grey tinted mirror  
EB: Espejo Bronze / Bronze tinted mirror

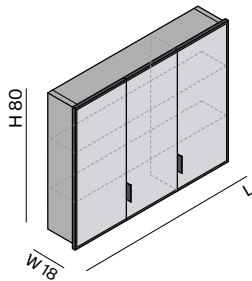

- ES Módulo auxiliar vitrina suspendido compuesto de tres puertas y dos estantes interiores.
- IT Modulo ausiliare vetrina sospeso composto da tre ante e due ripiani interni.
- EN Wall mounted cabinet unit with three doors and two internal shelves.
- GE Zusatzmodul Vitrinenschrank Hängemodul, bestehend aus drei Türen und zwei Ablagen innen.
- FR Armoire de toilette vitrée ou miroir encastrée à suspendre. Trois portes et deux étagères.
- RU Дополнительный подвесной модуль с тремя дверцами и двумя внутренними полками.

Observación: Los módulos ≤ L180 son indivisibles y se sirven en una única pieza / Units of ≤ L180 in length are one single unit and shipped as one / Les meubles ≤ L180 sont indivisibles et sont servis en une seule pièce / I moduli di ≤ L180 sono indivisibili e si forniscono in un solo pezzo / Die Module ≤ L180 werden als ganzes Stück geliefert und sind nicht einzeln erhältlich / Модули ≤ L180 выполнены в виде моноблока и потому н

**AUGMENTATION DE PRIX**

W min 13 cm

Cod.	L	A	S1	S3/S4
ST1127	90	1948	2127	2446
ST1128	120	2134	2320	2668
ST1129	140	2301	2485	2858
ST1130	150	2339	2530	2909
ST1131	160	2736	2919	3357
ST1127	90	1979	2156	2480
ST1128	120	2168	2352	2705
ST1129	140	2339	2521	2899
ST1130	150	2418	2605	2996
ST1131	160	2839	3016	3468

CR: Cristal incoloro / Untinted glass  
ES: Espejo / Untinted mirror

CG: Cristal Gris / Grey tinted glass  
CB: Cristal Bronze / Bronze tinted glass  
EG: Espejo Gris / Grey tinted mirror  
EB: Espejo Bronze / Bronze tinted mirror

A Antracita / Anthracite / Anthracite / Antracite / Anthrazit / Антрацит

S1 Madera natural / Natural wood / Bois Naturel / Legno Naturale / Echtholz / Натуральное дерево  
S3 Roble salvaje / Wild oak / Chêne sauvage / Rovere selvaggio / Natureiche / Дикий дуб  
S4 Roble Raw / Raw oak / Chêne Raw / Rovere Raw / Roheiche / Raw дуб

## STRATO

Módulos vitrina empotrados - Recessed Metallic black profile cabinets with glass doors - Armoires de toilette vitrées ou miroirs encastrées - Moduli con vetrina ad incasso - Kleinmöbel Module Einbauvitrine - Модули дополнительные встраиваемые со стеклянными или зеркальными дверцами

## AUXILIARES - MIRROR CABINETS AND COLUMNS

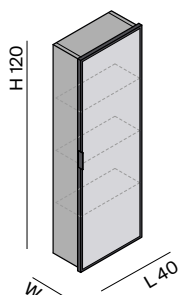

ES	Módulo auxiliar vitrina suspendido compuesto de una puerta y tres estantes interiores.	IT	Armadietto specchiera vetrina composto da un'anta e tre ripiani interni.
EN	Wall mounted cabinet unit with one door and three internal shelves.	GE	Zusatzmodul Vitrinenschrank Spiegel, bestehend aus einer Tür und drei Ablagen innen.
FR	Armoire de toilette vitrée ou miroir encastrée à suspendre. Une porte et trois étagères.	RU	Зеркальный шкаф с одной дверцей и тремя внутренними полками.

W min 13 cm

		Cod.	W	AUGMENTATION DE PRIX		
				A	S1	S3/S4
CR: Cristal incoloro / Untinted glass	ES: Espejo / Untinted mirror	ST1132	18	1250	1547	1779
		ST1133	30	1327	1667	1917
CG: Cristal Gris / Grey tinted glass	CB: Cristal Bronze / Bronze tinted glass	ST1132	18	1280	1577	1814
EG: Espejo Gris / Grey tinted mirror	EB: Espejo Bronze / Bronze tinted mirror	ST1133	30	1358	1698	1953

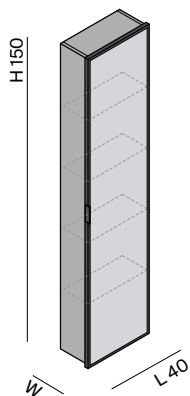

ES	Módulo auxiliar vitrina suspendido compuesto de una puerta y cuatro estantes interiores.	IT	Modulo ausiliare vetrina composto da un'anta e quattro ripiani interni.
EN	Wall mounted cabinet unit with one door and four internal shelves.	GE	Zusatzmodul Vitrinenschrank, bestehend aus einer Tür und vier Ablagen innen.
FR	Armoire de toilette vitrée ou miroir encastrée à suspendre. Une porte et quatre étagères.	RU	Дополнительный модуль с одной дверцей и четырьмя внутренними полками.

W min 13 cm

		Cod.	W	AUGMENTATION DE PRIX		
				A	S1	S3/S4
CR: Cristal incoloro / Untinted glass	ES: Espejo / Untinted mirror	ST1134	25	1397	1820	2093
		ST1135	40	1498	1823	2096
CG: Cristal Gris / Grey tinted glass	CB: Cristal Bronze / Bronze tinted glass	ST1134	25	1436	1858	2137
EG: Espejo Gris / Grey tinted mirror	EB: Espejo Bronze / Bronze tinted mirror	ST1135	40	1538	1860	2139
CE: Cristal Estriado / Fluted Glass	RB: Reflectivo Bronze / Bronze Reflective	ST1134	25	1580	2044	2351
		ST1135	40	1692	2046	2353

A Antracita / Anthracite / Anthracite / Antracite / Anthrazit / Антрацит

S1 Madera natural / Natural wood / Bois Naturel / Legno Naturale / Echtholz / Натуральное дерево

S3 Roble salvaje / Wild oak / Chêne sauvage / Rovere selvaggio / Natureiche / Дикая дуб

S4 Roble Raw / Raw oak / Chêne Raw / Rovere Raw / Roheiche / Raw дуб

## STRATO

Módulos vitrina empotrados - Recessed Metallic black profile cabinets with glass doors - Armoires de toilette vitrées ou miroirs encastrées - Moduli con vetrina ad incasso - Kleinmöbel Module Einbauvitrine - Модули дополнительные встраиваемые со стеклянными или зеркальными дверцами

## AUXILIARES - MIRROR CABINETS AND COLUMNS

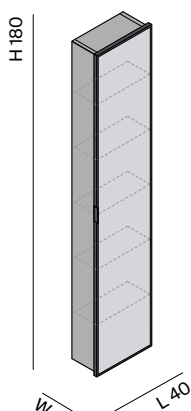

W min 13 cm

ES	Módulo auxiliar vitrina suspendido compuesto de una puerta y cinco estantes interiores.	IT	Modulo ausiliare vetrina composto da un'anta e cinque ripiani interni.
EN	Wall mounted cabinet unit with one door and five internal shelves.	GE	Zusatzmodul Vitrinenschrank, bestehend aus einer Tür und fünf Ablagen innen.
FR	Armoire de toilette vitrée ou miroir encastrée à suspendre. Une porte et cinq étagères.	RU	Дополнительный модуль с одной дверцей и пятью внутренними полками.

### AUGMENTATION DE PRIX

	Cod.	W	A	S1	S3/S4
CR: Cristal incoloro / Untinted glass	ST1136	25	1507	2074	2386
ES: Espejo / Untinted mirror	ST1137	40	1629	2196	2526
CG: Cristal Gris / Grey tinted glass	ST1136	25	1554	2119	2437
CB: Cristal Bronze / Bronze tinted glass	ST1137	40	1676	2241	2577
EG: Espejo Gris / Grey tinted mirror	ST1136	25	1710	2331	2681
EB: Espejo Bronze / Bronze tinted mirror	ST1137	40	1843	2465	2835
CE: Cristal Estriado / Fluted Glass	ST1136	25			
RB: Reflectivo Bronze / Bronze Reflective	ST1137	40			

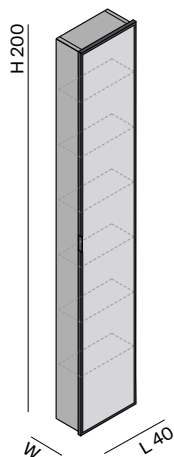

W min 13 cm

ES	Módulo auxiliar vitrina al suelo compuesto de una puerta y seis estantes interiores.	IT	Modulo ausiliare vetrina composto da un'anta e sei ripiani interni.
EN	Wall mounted cabinet unit with one door and six internal shelves.	GE	Zusatzmodul Vitrinenschrank, bestehend aus einer Tür und sechs Ablagen innen.
FR	Armoire de toilette vitrée ou miroir encastrée au sol. Une porte et six étagères.	RU	Дополнительный модуль с одной дверцей и шестью внутренними полками.

### AUGMENTATION DE PRIX

	Cod.	W	A	S1	S3/S4
CR: Cristal incoloro / Untinted glass	ST1138	25	1677	2386	2744
ES: Espejo / Untinted mirror	ST1139	40	1820	2530	2909
CG: Cristal Gris / Grey tinted glass	ST1138	25	1731	2437	2803
CB: Cristal Bronze / Bronze tinted glass	ST1139	40	1872	2581	2968
EG: Espejo Gris / Grey tinted mirror	ST1138	25	1904	2681	3083
EB: Espejo Bronze / Bronze tinted mirror	ST1139	40	2059	2839	3265
CE: Cristal Estriado / Fluted Glass	ST1138	25			
RB: Reflectivo Bronze / Bronze Reflective	ST1139	40			

A Antracita / Anthracite / Anthracite / Antracite / Anthrazit / Антрацит

S1 Madera natural / Natural wood / Bois Naturel / Legno Naturale / Echtholz / Натуральное дерево

S3 Roble salvaje / Wild oak / Chêne sauvage / Rovere selvaggio / Natureiche / Дикая дуб

S4 Roble Raw / Raw oak / Chêne Raw / Rovere Raw / Roheiche / Raw дуб

## STRATO

Módulos vitrina empotrados - Recessed Metallic black profile cabinets with glass doors - Armoires de toilette vitrées ou miroirs encastrées - Moduli con vetrina ad incasso - Kleinmöbel Module Einbauvitrine - Модули дополнительные встраиваемые со стеклянными или зеркальными дверцами

## AUXILIARES - MIRROR CABINETS AND COLUMNS

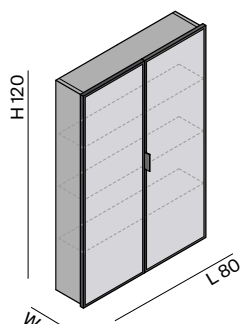

ES	Módulo auxiliar vitrina compuesto de dos puertas y tres estantes interiores.	IT	Modulo ausiliare vetrina composto da due ante e tre ripiani interni.
EN	Wall mounted cabinet unit with two doors and three internal shelves.	GE	Zusatzmodul Vitrinenschrank, bestehend aus einer Tür und drei Ablagen innen.
FR	Armoire de toilette vitrée ou miroir encastrée à suspendre. Deux portes et trois étagères.	RU	Дополнительный модуль с двумя дверцами и тремя внутренними полками.

W min 13 cm

Cod.	W	AUGMENTATION DE PRIX			
		A	S1	S3/S4	
CR: Cristal incoloro / Untinted glass ES: Espejo / Untinted mirror	ST1148	18	2266	2804	3225
	ST1149	30	2407	3030	3476
CG: Cristal Gris / Grey tinted glass CB: Cristal Bronze / Bronze tinted glass EG: Espejo Gris / Grey tinted mirror EB: Espejo Bronze / Bronze tinted mirror	ST1148	18	2322	2860	3289
	ST1149	30	2463	3079	3540

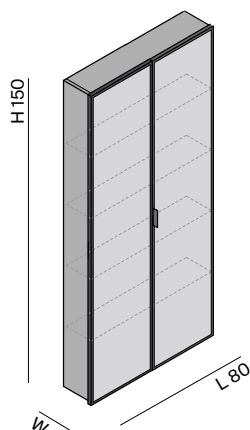

ES	Módulo auxiliar vitrina compuesto de dos puertas y cuatro estantes interiores.	IT	Modulo ausiliare vetrina composto da due ante e quattro ripiani interni.
EN	Wall mounted cabinet unit with two doors and four internal shelves.	GE	Zusatzmodul Vitrinenschrank, bestehend aus einer Tür und vier Ablagen innen.
FR	Armoire de toilette vitrée ou miroir encastrée à suspendre. Deux portes et quatre étagères.	RU	Дополнительный модуль с двумя дверцами и четырьмя внутренними полками.

W min 13 cm

Cod.	W	AUGMENTATION DE PRIX			
		A	S1	S3/S4	
CR: Cristal incoloro / Untinted glass ES: Espejo / Untinted mirror	ST1150	25	2533	3300	3795
	ST1151	40	2716	3305	3801
CG: Cristal Gris / Grey tinted glass CB: Cristal Bronze / Bronze tinted glass EG: Espejo Gris / Grey tinted mirror EB: Espejo Bronze / Bronze tinted mirror	ST1150	25	2604	3370	3875
	ST1151	40	2789	3373	3878
CE: Cristal Estriado / Fluted Glass RB: Reflectivo Bronze / Bronze Reflective	ST1150	25	2864	3707	4263
	ST1151	40	3068	3710	4266

A Antracita / Anthracite / Anthracite / Antracite / Anthrazit / Антрацит

S1 Madera natural / Natural wood / Bois Naturel / Legno Naturale / Echtholz / Натуральное дерево

S3 Roble salvaje / Wild oak / Chêne sauvage / Rovere selvaggio / Natureiche / Дикая дуб

S4 Roble Raw / Raw oak / Chêne Raw / Rovere Raw / Roheiche / Raw дуб

## STRATO

Módulos vitrina empotrados - Recessed Metallic black profile cabinets with glass doors - Armoires de toilette vitrées ou miroirs encastrées - Moduli con vetrina ad incasso - Kleinmöbel Module Einbauvitrine - Модули дополнительные встраиваемые со стеклянными или зеркальными дверцами

## AUXILIARES - MIRROR CABINETS AND COLUMNS

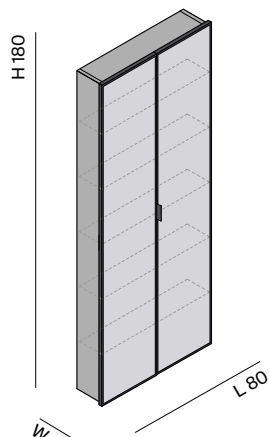

W min 13 cm

ES	Módulo auxiliar vitrina compuesto de dos puertas y cinco estantes interiores.	IT	Modulo ausiliare vetrina composto da due ante e cinque ripiani interni.
EN	Wall mounted cabinet unit with two doors and five internal shelves.	GE	Zusatzmodul Vitrinenschrank, bestehend aus einer Tür und fünf Ablagen innen.
FR	Armoire de toilette vitrée ou miroir encastrée à suspendre. Deux portes et cinq étagères.	RU	Дополнительный модуль с двумя дверцами и пятью внутренними полками.

### AUGMENTATION DE PRIX

	Cod.	W	A	S1	S3/S4
CR: Cristal incoloro / Untinted glass ES: Espejo / Untinted mirror	ST1152	25	2733	3762	4326
	ST1153	40	2953	3983	4580
CG: Cristal Gris / Grey tinted glass CB: Cristal Bronze / Bronze tinted glass EG: Espejo Gris / Grey tinted mirror EB: Espejo Bronze / Bronze tinted mirror	ST1152	25	2818	3843	4419
	ST1153	40	3039	4181	4673
CE: Cristal Estriado / Fluted Glass RB: Reflectivo Bronze / Bronze Reflective	ST1152	25	3100	4227	4861
	ST1153	40	3342	4599	5141

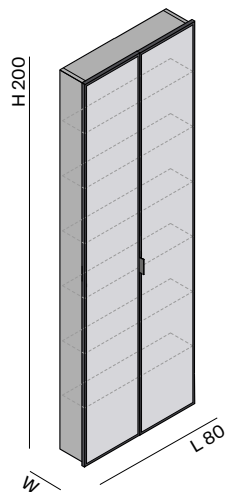

W min 13 cm

ES	Módulo auxiliar vitrina compuesto de dos puertas y seis estantes interiores	IT	Modulo ausiliare vetrina composto da due ante e sei ripiani interni.
EN	Wall mounted cabinet unit with two doors and six internal shelves.	GE	Zusatzmodul Vitrinenschrank, bestehend aus einer Tür und sechs Ablagen innen.
FR	Armoire de toilette vitrée ou miroir encastrée au sol. Deux portes et six étagères.	RU	Дополнительный модуль с двумя дверцами и шестью внутренними полками.

### AUGMENTATION DE PRIX

	Cod.	W	A	S1	S3/S4
CR: Cristal incoloro / Untinted glass ES: Espejo / Untinted mirror	ST1154	25	3042	4327	4976
	ST1155	40	3300	4587	5275
CG: Cristal Gris / Grey tinted glass CB: Cristal Bronze / Bronze tinted glass EG: Espejo Gris / Grey tinted mirror EB: Espejo Bronze / Bronze tinted mirror	ST1154	25	3111	4423	5082
	ST1155	40	3394	4680	5381
CE: Cristal Estriado / Fluted Glass RB: Reflectivo Bronze / Bronze Reflective	ST1154	25	3422	4865	5590
	ST1155	40	3734	5147	5920

A Antracita / Anthracite / Anthracite / Antracite / Anthrazit / Антрацит

S1 Madera natural / Natural wood / Bois Naturel / Legno Naturale / Echtholz / Натуральное дерево

S3 Roble salvaje / Wild oak / Chêne sauvage / Rovere selvaggio / Natureiche / Дикая дуб

S4 Roble Raw / Raw oak / Chêne Raw / Rovere Raw / Roheiche / Raw дуб



## STRATO

Módulos vitrina empotrados - Recessed Metallic black profile cabinets with glass doors - Armoires de toilette vitrées ou miroirs encastrées - Moduli con vetrina ad incasso - Kleinmöbel Module Einbauvitrine - Модули дополнительные встраиваемые со стеклянными или зеркальными дверцами

## AUXILIARES - MIRROR CABINETS AND COLUMNS

Complementos para módulos auxiliares vitrina / Cabinet unit accessories / Compléments Pour Meubles D'appoints Vitrés / Complementi per moduli ausiliari vetrina / Zubehör für Zusatzmodule Vitrinenschrank / аксессуары для дополнительных модулей



ES	Base de enchufe interior doble. Instalado en el mueble.	IT	Presa interna doppia. Installato nel mobile.
EN	Interior socket with two outlets. Installed into the unit.	GE	Innen liegende doppelsteckdose. Installiert im Möbel.
FR	Prise électrique double. Installée à l'intérieur du meuble.	RU	Двойная внутренняя розетка. Встроена в модуль.

**AUGMENTATION  
DE PRIX**

Cod.

EF010

191

**IP44**

**CE UK  
IP41**

Cod.

EF010 UK 115V / 230V dual voltage shaver socket with two outlets. Installed into the unit.

381



ES	2 líneas de iluminación LED interior lateral para módulos de diferente alto (H). Encendido mediante sensor al abrir la puerta en puertas espejo o encendido mediante toma directa a corriente para puertas en cristal.	IT	2 strisce di illuminazione LED interna laterale per moduli di diversa altezza (H). Accensione mediante sensore di apertura dell'anta in ante con specchio o accensione mediante presa di corrente diretta per ante di vetro.
EN	Two interior side lighting LED stripes for cabinets of different heights (H). Sensor-controlled light switching when opening/closing the door needs to be added.	GE	Zwei seitliche Lichtlinien LED innen, für Module in verschiedener Höhe (H). Automatisches Einschalten durch Sensor beim Öffnen der Tür, Tür mit Spiegel. Einschaltfunktion für Tür aus Kristall: Direktanschluss.
FR	Deux bandes latérales intérieures d'éclairage LED pour meubles de différentes hauteur (H). Mise en marche à l'aide d'un capteur lors de l'ouverture de la porte miroir ou directement par prise de courant pour les portes vitrées.	RU	2 линии внутренней боковой LED-подсветки для модулей разной высоты (H). Включение от датчика в момент открытия зеркальных дверец или с помощью электрического выключателя для модулей со стеклянными дверцами.

Cod.	H	
IL061	40	282
IL062	60	298
IL063	80	315
IL065	120	350
IL067	150	434
IL068	180	459
IL069	200	477
+ {		
Solo para puertas espejo / Only for mirror doors is required		
CF002	Sensor / Capteur / Sensore / Датчика	139

Tapas con lavabo integrado solidsurface · Solidsurface tops with integrated washbasins · Plan avec vasque intégrée solidsurface · Coperchi con lavandino integrato solidsurface · Abdeckungen mit integriertem waschbecken solidsurface · Тонкая столешница со встроенной раковиной из материала solidsurface

TAPAS - TOPS

GIRO35 Solidsurface

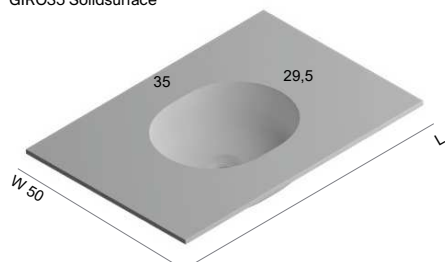

<b>ES</b>	Tapas con lavabo integrado en Solidsurface. Espesor 12 mm.	<b>IT</b>	Coperchio con lavandino integrato in Solidsurface. Spessore di 12mm.
<b>EN</b>	Matt Solidsurface 12mm top with integrated washbasin.	<b>GE</b>	Abdeckung mit integriertem Waschbecken aus Solidsurface. Dicke 12 mm.
<b>FR</b>	Plan vasque intégrée en Solidsurface mat. Épaisseur 12mm.	<b>RU</b>	Тонкая столешница со встроенной раковиной из материала Solidsurface. Толщина 12 мм.

**(A)** Distancia mínima CON agujero de grifería 8 cm / Minimum distance with tap hole – 8cm / Distance minimum avec perçement de robinetterie: 8cm / Distanza minima con foratura di rubinetteria 8 cm / Mindestabstand mit Hahnloch 8 cm / Минимальное расстояние ПРИ НАЛИЧИИ отверстия под смеситель – 8 см  
 Distancia mínima SIN agujero de grifería 4 cm / Minimum distance without tap hole – 4cm / Distance minimum sans perçement robinetterie: 4cm / Distanza minima senza foratura di rubinetteria 4 cm / Mindestabstand ohne Hahnloch 4 cm / Минимальное расстояние БЕЗ отверстия под смеситель – 4 см



<b>(B)</b>	STRATO / HERITAGE / EASE	GRATE / PARAL	Grate	СТГТ004	+15%	W 51-60	+30%
	12 mm	45° 12 mm	Paral	СТРА004	+15%	W 61-90	+50%

**AUGMENTATION DE PRIX**

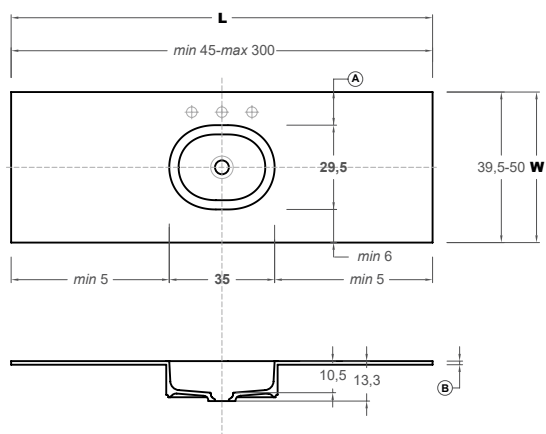

Cod.		L	Solidsurface	UHS
ST419RM	GR35	60	907	1311
ST420RM	GR35	80	960	1364
ST422RM	GR35	90	972	1375
ST423RM	GR35	100	1080	1484
ST486RM	GR35	120	1111	1515
ST429RM	GR35	140	1225	1673
ST432RM	GR35	160	1323	1770
ST435RM	GR35	180	1420	1868
ST438RM	GR35	200	1737	2185
ST442RM	GR35	220	1856	2369
ST443RM	GR35	240	2026	2540
ST444RM	GR35	260	2141	2654
ST446RM	GR35	280	2414	2928
ST448RM	GR35	300	2557	3070

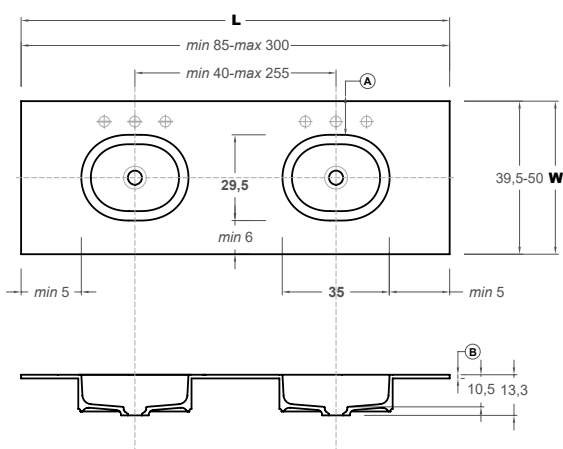

Cod.		L	Solidsurface	UHS
ST540RM	GR35	120	1584	2117
ST541RM	GR35	140	1756	2347
ST434RM	GR35	160	1950	2542
ST437RM	GR35	180	2142	2734
ST439RM	GR35	200	2365	2957
ST440RM	GR35	220	2619	3270
ST441RM	GR35	240	2875	3527
ST245RM	GR35	260	3131	3783
ST247RM	GR35	280	3386	4037
ST249RM	GR35	300	3642	4293

 Lacado UHS color a elegir / UHS colour coating. Colour to be chosen / Laqué UHS à choisir / Laccato UHS, colore a scelta / Oberflächenbeschichtung Lack Ultra-High-Solid- (UHS)System. Farbe nach Wahl / Цветное покрытие UHS. Цвет на выбор.

Tapas con lavabo integrado solidsurface · Solidsurface tops with integrated washbasins · Plan avec vasque intégrée solidsurface · Coperchi con lavandino integrato solidsurface · Abdeckungen mit integriertem waschbecken solidsurface · Тонкая столешница со встроенной раковиной из материала solidsurface

TAPAS - TOPS

PRIME Solidsurface

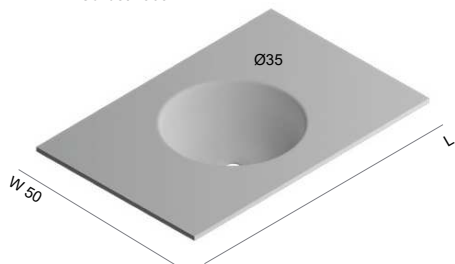

<b>ES</b>	Tapas con lavabo integrado en Solidsurface. Espesor 12 mm.	<b>IT</b>	Coperchio con lavandino integrato in Solidsurface. Spessore di 12mm.
<b>EN</b>	Matt Solidsurface 12mm top with integrated washbasin.	<b>GE</b>	Abdeckung mit integriertem Waschbecken aus Solidsurface. Dicke 12 mm.
<b>FR</b>	Plan vasque intégrée en Solidsurface mat. Épaisseur 12mm.	<b>RU</b>	Тонкая столешница со встроенной раковиной из материала Solidsurface. Толщина 12 мм.

**(A)** Distancia mínima CON agujero de grifería 8 cm / Minimum distance with tap hole – 8cm / Distance minimum avec percement de robinetterie: 8cm / Distanza minima con foratura di rubinetteria 8 cm / Mindestabstand mit Hahnloch 8 cm / Минимальное расстояние ПРИ НАЛИЧИИ отверстия под смеситель – 8 см  
 Distancia mínima SIN agujero de grifería 4 cm / Minimum distance without tap hole – 4cm / Distance minimum sans percement robinetterie: 4cm / Distanza minima senza foratura di rubinetteria 4 cm / Mindestabstand ohne Hahnloch 4 cm / Минимальное расстояние БЕЗ отверстия под смеситель – 4 см



<b>(B)</b>	<b>STRATO / HERITAGE / EASE</b>	<b>GRATE / PARAL</b>	Grate	СТГТ004	+15%	W 51-60	+30%
	12 mm	45° 12 mm	Paral	СТРА004	+15%	W 61-90	+50%

**AUGMENTATION DE PRIX**

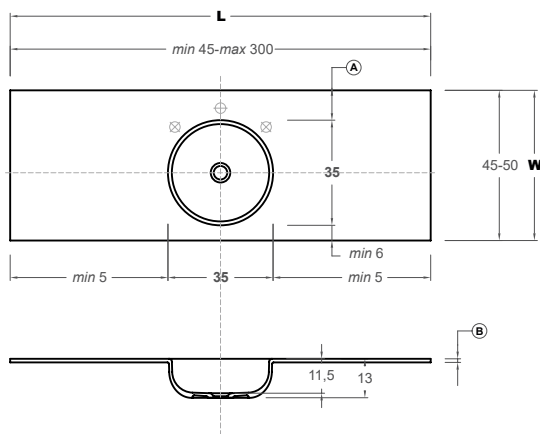

Cod.		L	Solidsurface	UHS
ST419RM	PR	60	932	1336
ST420RM	PR	80	1006	1410
ST422RM	PR	90	1011	1415
ST423RM	PR	100	1216	1620
ST486RM	PR	120	1316	1720
ST429RM	PR	140	1377	1825
ST432RM	PR	160	1544	1992
ST435RM	PR	180	1621	2069
ST438RM	PR	200	1811	2259
ST442RM	PR	220	2012	2525
ST443RM	PR	240	2189	2702
ST444RM	PR	260	2301	2814
ST446RM	PR	280	2557	3070
ST448RM	PR	300	2798	3312

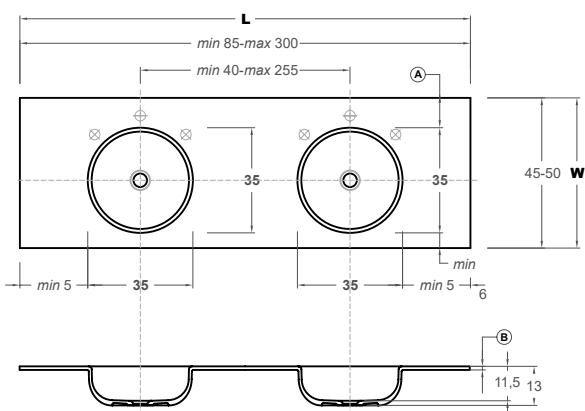

Cod.		L	Solidsurface	UHS
ST540RM	PR	120	1852	2385
ST541RM	PR	140	1950	2542
ST434RM	PR	160	2142	2734
ST437RM	PR	180	2365	2957
ST439RM	PR	200	2619	3211
ST440RM	PR	220	2875	3527
ST441RM	PR	240	3131	3783
ST245RM	PR	260	3386	4037
ST247RM	PR	280	3642	4293
ST249RM	PR	300	3678	4329

 Lacado UHS color a elegir / UHS colour coating. Colour to be chosen / Laqué UHS à choisir / Laccato UHS, colore a scelta / Oberflächenbeschichtung Lack Ultra-High-Solid- (UHS)System. Farbe nach Wahl / Цветное покрытие UHS. Цвет на выбор.

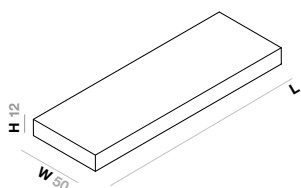

Cod.	L	LM	LB	S1	S3/S4	Solidsurface	UHS	MDi
MS01080	80	357	392	451	519	643	1047	1991
MS01090	90	401	441	508	584	682	1086	2086
MS01100	100	448	492	566	651	740	1144	2181
MS01110	110	492	542	623	716	810	1214	2274
MS01120	120	537	591	679	781	881	1285	2369
MS01130	130	580	638	734	844	1073	1520	2464
MS01140	140	627	689	793	912	1265	1713	2558
MS01150	150	671	739	849	977	1306	1753	2760
MS01160	160	716	788	906	1042	1347	1794	2854
MS01170	170	761	837	963	1107	1465	1912	2949
MS01180	180	807	888	1021	1174	1584	2031	3044
MS01190	190	850	936	1076	1237	1709	2157	3138
MS01200	200	894	983	1131	1300	1835	2283	1913
MS01210	210	938	1032	1187	1365	2051	2564	3584
MS01220	220	986	1085	1248	1435	2049	2562	3678
MS01230	230	1036	1139	1310	1507	2138	2652	-
MS01240	240	1087	1195	1375	1581	2135	2648	-

W 51-65 +20%



<b>ES</b>	Escuadra de sujeción. Cada 50 cm.	<b>IT</b>	Squadre di sostegno, posizionare una ogni 50 cm.
<b>EN</b>	Fixing bracket. To be placed every 50cm.	<b>GE</b>	Montagewinkel, Anbringung eines Winkels alle 50 cm.
<b>FR</b>	Équerres de fixation, en poser une tous les 50cm.	<b>RU</b>	Крепежные уголки. Интервал – 50 см.

Cod.

EC233A

**AUGMENTATION  
DE PRIX**

79

LM Laca Mate / Matt Lacquer / Laqué Mat / Laccato Opaco / Mattlack / Матовый лак  
 LB Laca Brillo / Glossy Lacquer / Laqué Brillant / Lacca Lucida / Glanzlack / Глянцевая медь

S1 Madera Natural / Natural Wood / Bois Naturel / Legno Naturale / Echtholz / Натуральное дерево  
 S3 Roble Salvaje / Wild Oak / Chêne Sauvage / Rovere Selvaggio / Natureiche / Дикая дуб  
 S4 Roble Raw / Raw oak / Chêne Raw / Rovere Raw / Roheiche / Raw дуб

PARAL60 design Victor Carrasco

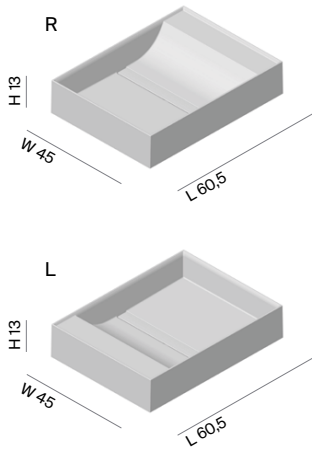

**ES** Lavabo sobre encimera o suspendido en Solidsurface mate con desagüe libre y tapa oculta desagüe incluido. Con opción de agujero(s) para grifería. Sin rebosadero. Sifón necesario.

**IT** Lavabo da appoggio o sospeso in Solidsurface opaco con scarico libero e top con piletta nascosta inclusi. Con opzione dei fori per la rubinetteria. Sifone necessario. Senza troppopieno.

**EN** Top or wall mounted washbasin in matt Solidsurface with free flow drainage and drain cover included. Possibility of tap hole(s). Without overflow. Siphon is required.

**GE** Aufsatz- oder freies Einzelwaschbecken in Solidsurface matt, freier Ablauf und zugehörige Abdeckung inbegriffen. Öffnung für Wascharmatur ist optional. Siphon nicht inbegriffen. Ohne Überlauf.

**FR** Lavabo suspendu ou à poser en Solidsurface mate. Écoulement libre et cache bonde inclus. Possibilité percement robinetterie. Sans déversoir. Siphon nécessaire.

**RU** Раковина на столешницу или подвесная из материала Solidsurface с матовой отделкой. Свободный водослив и накладка на сливное отверстие в комплекте. Возможно изготовление отверстия (-й) под смеситель. Требуются сифон. Без переливного отверстия.

**AUGMENTATION DE PRIX**

Cod.

PA000R

PA000L

	Solidsurface	UHS
PA000R	805	1196
PA000L	805	1196

Sólo para suspender lavabo a pared  
 Just required for wall mounted version



**PASSO**

Kit de fijación a pared para lavabo PA000 / Wall fixing basic kit for PA000 washbasin / Kit de base pour fixation murale du lavabo PA000 / Kit di fissaggio a parete per lavabo PA000 / Befestigungs-Kit für Waschbecken PA000. Wandbefestigung / Набор для крепления на стену раковины PA000

76

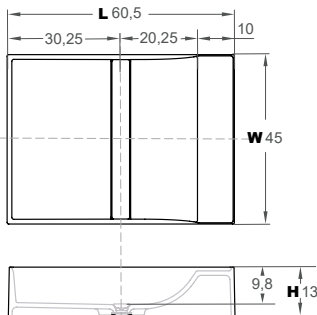

**Net weight** 11,9kg  
**Gross weight** 13kg  
**Packing dimensions** 64x48x16cm  
**Packing volume** 0,049m<sup>3</sup>



Lacado UHS color a elegir / UHS colour coating. Colour to be chosen / Laqué UHS à choisir /  
 Laccato UHS, colore a scelta / Oberflächenbeschichtung Lack Ultra-High-Solid- (UHS)System.  
 Farbe nach Wahl / Цветное покрытие UHS. Цвет на выбор.

PARAL80 design Victor Carrasco

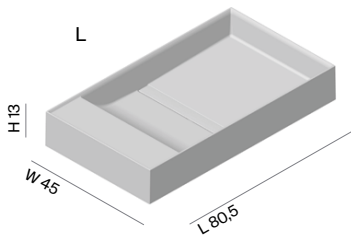
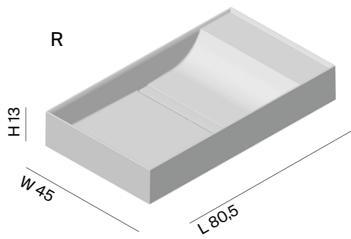

**ES** Lavabo sobre encimera o suspendido en Solidsurface mate con desagüe libre y tapa oculta desagüe incluido. Con opción de agujero(s) para grifería. Sin rebosadero. Sifón necesario.

**EN** Top or wall mounted washbasin in matt Solidsurface with free flow drainage and drain cover included. Possibility of tap hole(s). Without overflow. Siphon is required.

**FR** Lavabo suspendu ou à poser en Solidsurface mate. Écoulement libre et cache bonde inclus. Possibilité percement robinetterie. Sans déversoir. Siphon nécessaire.

**IT** Lavabo da appoggio o sospeso in Solidsurface opaco con scarico libero e top con piletta nascosta inclusi. Con opzione dei fori per la rubinetteria. Sifone necessario. Senza troppopieno.

**GE** Aufsatz- oder freies Einzelwaschbecken in Solidsurface matt, freier Ablauf und zugehörige Abdeckung inbegriffen. Öffnung für Wascharmatur ist optional. Siphon nicht inbegriffen. Ohne Überlauf.

**RU** Раковина на столешницу или подвесная из материала Solidsurface с матовой отделкой. Свободный водослив и накладка на сливное отверстие в комплекте. Возможно изготовление отверстия (-й) под смеситель. Требуются сифон. Без переливного отверстия.

**AUGMENTATION DE PRIX**

Cod.

PA001R

PA001L

	Solidsurface	UHS
PA001R	965	1355
PA001L	965	1355

Sólo para suspender lavabo a pared  
 Just required for wall mounted version



PASS1

Kit de fijación a pared para lavabo PA001 / Wall fixing basic kit for PA001 washbasin / Kit de base pour fixation murale du lavabo PA001 / Kit di fissaggio a parete per lavabo PA001 / Befestigungs-Kit für Waschbecken PA001. Wandbefestigung / Набор для крепления на стену раковины PA001

76

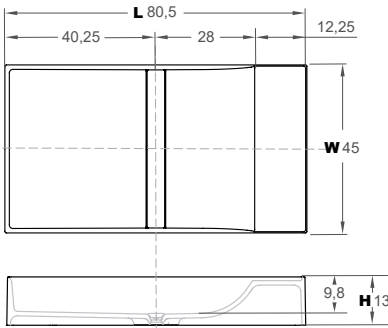

**Net weight** 14,9kg  
**Gross weight** 16kg  
**Packing dimensions** 84x48x16cm  
**Packing volume** 0,064m<sup>3</sup>



Lacado UHS color a elegir / UHS colour coating. Colour to be chosen / Laqué UHS à choisir /  
 Laccato UHS, colore a scelta / Oberflächenbeschichtung Lack Ultra-High-Solid- (UHS)System.  
 Farbe nach Wahl / Цветное покрытие UHS. Цвет на выбор.

PARAL100 design Víctor Carrasco

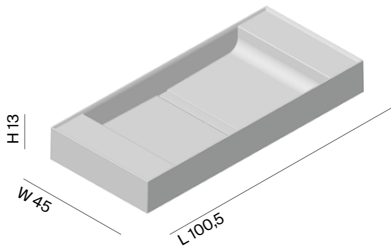

**ES** Lavabo sobre encimera o suspendido en Solidsurface mate con desagüe libre y tapa oculta desagüe incluido. Con opción de agujero(s) para grifería. Sin rebosadero. Sifón necesario.

**IT** Lavabo da appoggio o sospeso in Solidsurface opaco con scarico libero e top con piletta nascosta inclusi. Con opzione dei fori per la rubinetteria. Sifone necessario. Senza troppopieno.

**EN** Top or wall mounted washbasin in matt Solidsurface with free flow drainage and drain cover included. Possibility of tap hole(s). Without overflow. Siphon is required.

**GE** Aufsatz- oder freies Einzelwaschbecken in Solidsurface matt, freier Ablauf und zugehörige Abdeckung inbegriffen. Öffnung für Wascharmatur ist optional. Siphon nicht inbegriffen. Ohne Überlauf.

**FR** Lavabo suspendu ou à poser en Solidsurface mat. Écoulement libre et cache bonde inclus. Possibilité percement robinetterie. Sans déversoir. Siphon nécessaire.

**RU** Раковина на столешницу или подвесная из материала Solidsurface с матовой отделкой. Свободный водослив и накладка на сливное отверстие в комплекте. Возможно изготовление отверстия (-й) под смеситель. Требуются сифон. Без переливного отверстия.

**AUGMENTATION  
DE PRIX**

Cod.

PA002

Solidsurface	UHS
1167	1626

Sólo para suspender lavabo a pared  
Just required for wall mounted version



PASS2

Kit de fijación a pared para lavabo PA002 / Wall fixing basic kit for PA002 washbasin / Kit de base pour fixation murale du lavabo PA002 / Kit di fissaggio a parete per lavabo PA002 / Befestigungs-Kit für Waschbecken PA002. Wandbefestigung / Набор для крепления на стену раковины PA002

76

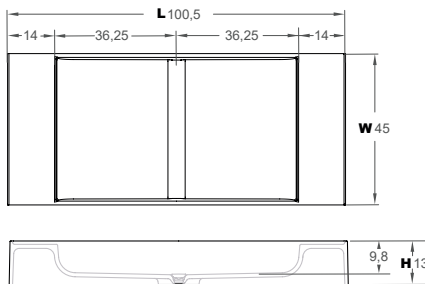

Net weight	18,2kg
Gross weight	20kg
Packing dimensions	104x48x16cm
Packing volume	0,079m <sup>3</sup>



Lacado UHS color a elegir / UHS colour coating. Colour to be chosen / Laqué UHS à choisir /  
 Laccato UHS, colore a scelta / Oberflächenbeschichtung Lack Ultra-High-Solid- (UHS)System.  
 Farbe nach Wahl / Цветное покрытие UHS. Цвет на выбор.

SI201

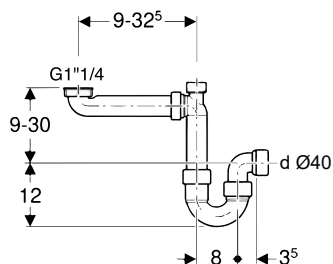

- |    |  |    |  |
|----|--|----|--|
| ES | Sifón ahorro espacio para lavabo con tubo modificable en PVC blanco.     | IT | Sifone risparmio spazio per lavandino con tubo modificabile in PVC bianco.       |
| EN | Space-saving siphon for washbasin with adjustable pipe in white PVC.     | GE | Siphon platzsparend für Waschbecken mit Rohr veränderbar aus weißem PVC.         |
| FR | Siphon économie d'espace pour lavabo avec tuyau modifiable en PVC blanc. | RU | Сифон экономящий пространство для раковины с трубой модифицируемой в белого ПВХ. |

**AUGMENTATION DE PRIX**

Cod.

SI201

PVC

111

SI225

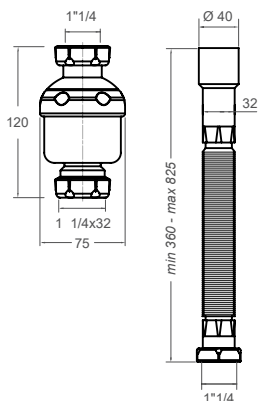

- |    |   |    |  |
|----|---|----|--|
| ES | Sifón vertical para lavabo con tubo flexible para instalación al suelo en PVC blanco.           | IT | Sifone verticale per lavandino con tubo flessibile per installazione al pavimento in PVC bianco. |
| EN | Vertical siphon for washbasin with adjustable pipe for installation to the ground in white PVC. | GE | Vertikaler Siphon für Waschbecken mit flexiblem Rohr aus weißem PVC für die Bodeninstallation.   |
| FR | Siphon vertical pour lavabo avec tuyau flexible pour une installation au sol en PVC blanc.      | RU | Вертикальный сифон для раковины из белого ПВХ с гибкой трубой для напольной установки.           |

**AUGMENTATION DE PRIX**

Cod.

SI225

PVC

88

RB001

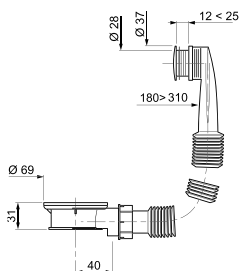

- |    |                               |    |                                  |
|----|-------------------------------|----|----------------------------------|
| ES | Kit rebosadero para lavabo.   | IT | Kit scarico per lavandino.       |
| EN | Washbasin overflow kit.       | GE | Überlaufbausatz für Waschbecken. |
| FR | Kit de déversoir pour vasque. | RU | Комплект водослива для раковины. |

Cod.

RB001A

PVC

156



PRIME design by Norm Architects

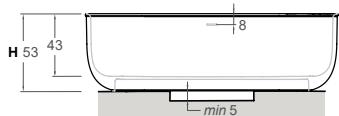
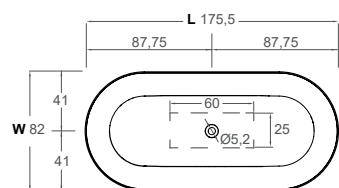

**ES** Bañera exenta en Solidsurface mate. Con rebosadero. Válvula en Solidsurface mate y sifón en PVC incluidos.

**EN** Matt Solidsurface freestanding bathtub. With overflow. Matt Solidsurface waste and PVC siphon included.

**FR** Baignoire flot en Solidsurface mat. Avec déversoir. Bonde en Solidsurface mat et siphon en PVC inclus.

**IT** Vasca da bagno freestanding in Solidsurface opaco. Con troppopieno. Valvola in Solidsurface opaco e sifone in PVC inclusi.

**GE** Freistehende Badewanne mit matter Solid-Surface-Oberfläche und mit Überlauf. Ventil in Solidsurface matt und Siphon (PVC) im Lieferumfang enthalten.

**RU** Отдельностоящая матовая ванна из Solidsurface. С отверстием перелива воды. Донный клапан из материала Solidsurface с матовой отделкой и сифон из ПВХ в комплекте.

Cod.

PRO11

Capacity 380l.  
 Net weight 183kg  
 Gross weight 217kg  
 Packing dimensions 188x94x74cm  
 Packing volume 1,308m³

**AUGMENTATION  
 DE PRIX**

Solidsurface	UHS
6172	7455



Lacado UHS color a elegir / UHS colour coating. Colour to be chosen / Laqué UHS à choisir / Laccato UHS, colore a scelta / Oberflächenbeschichtung Lack Ultra-High-Solid- (UHS)System. Farbe nach Wahl / Цветное покрытие UHS. Цвет на выбор.